



Measuring concept and key messages to the user behaviour

Dipl.-Ing. (FH) Michael Braun, M.Sc.
Energieinstitut Vorarlberg

Hefel Lauterach



Hefel Lauterach



Hefel Lauterach



Hefel Lauterach



Hefel Lauterach



Hefel Lauterach

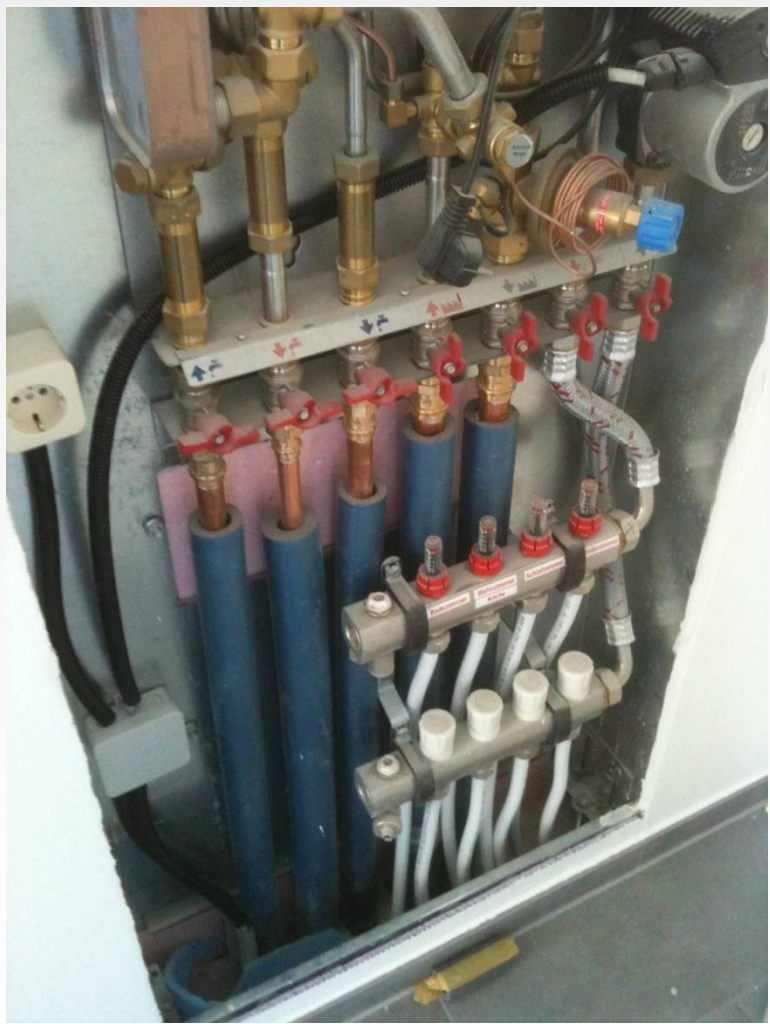

Hefel Lauterach

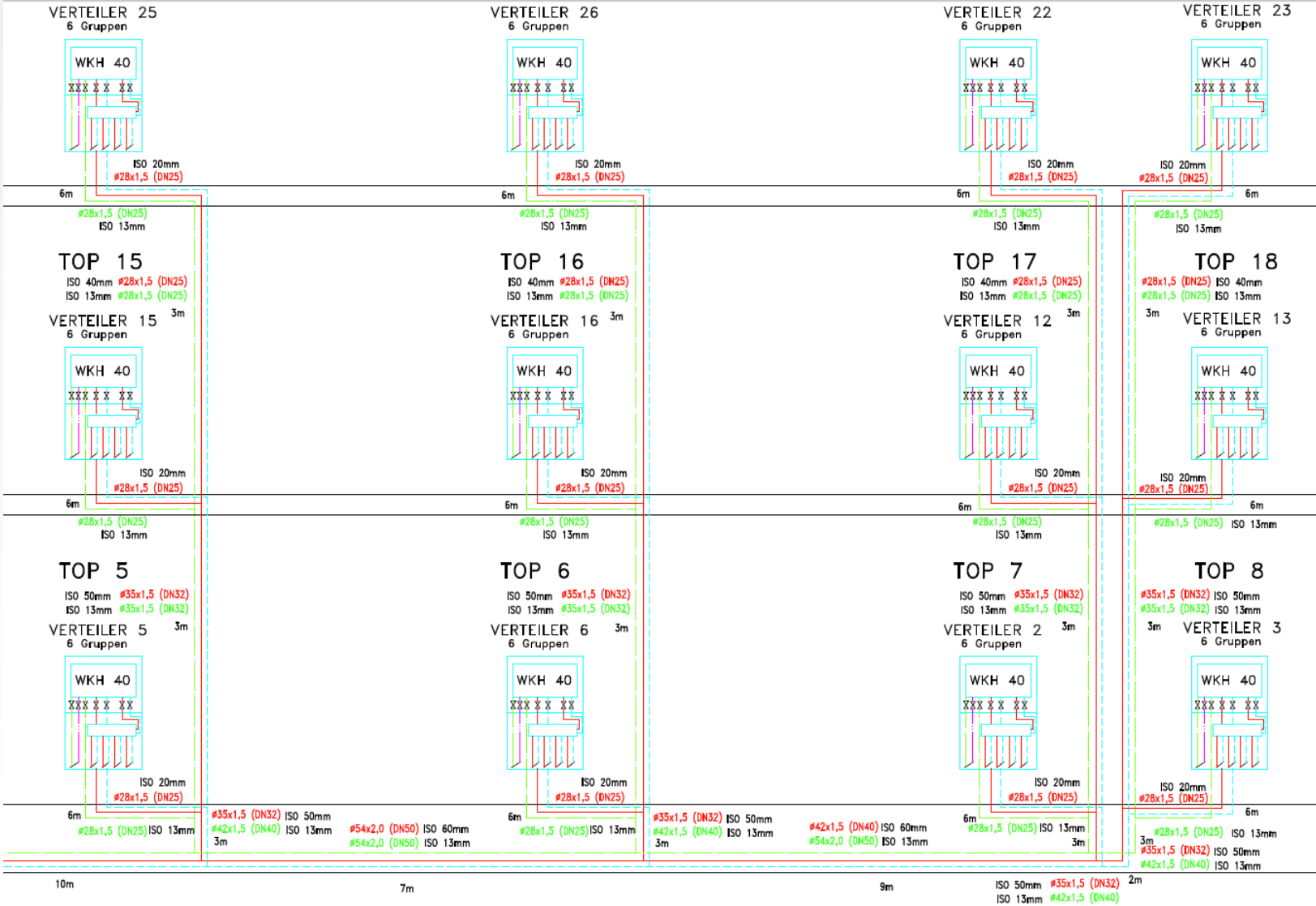

Hefel Lauterach



Hefel Lauterach



Hefel Lauterach

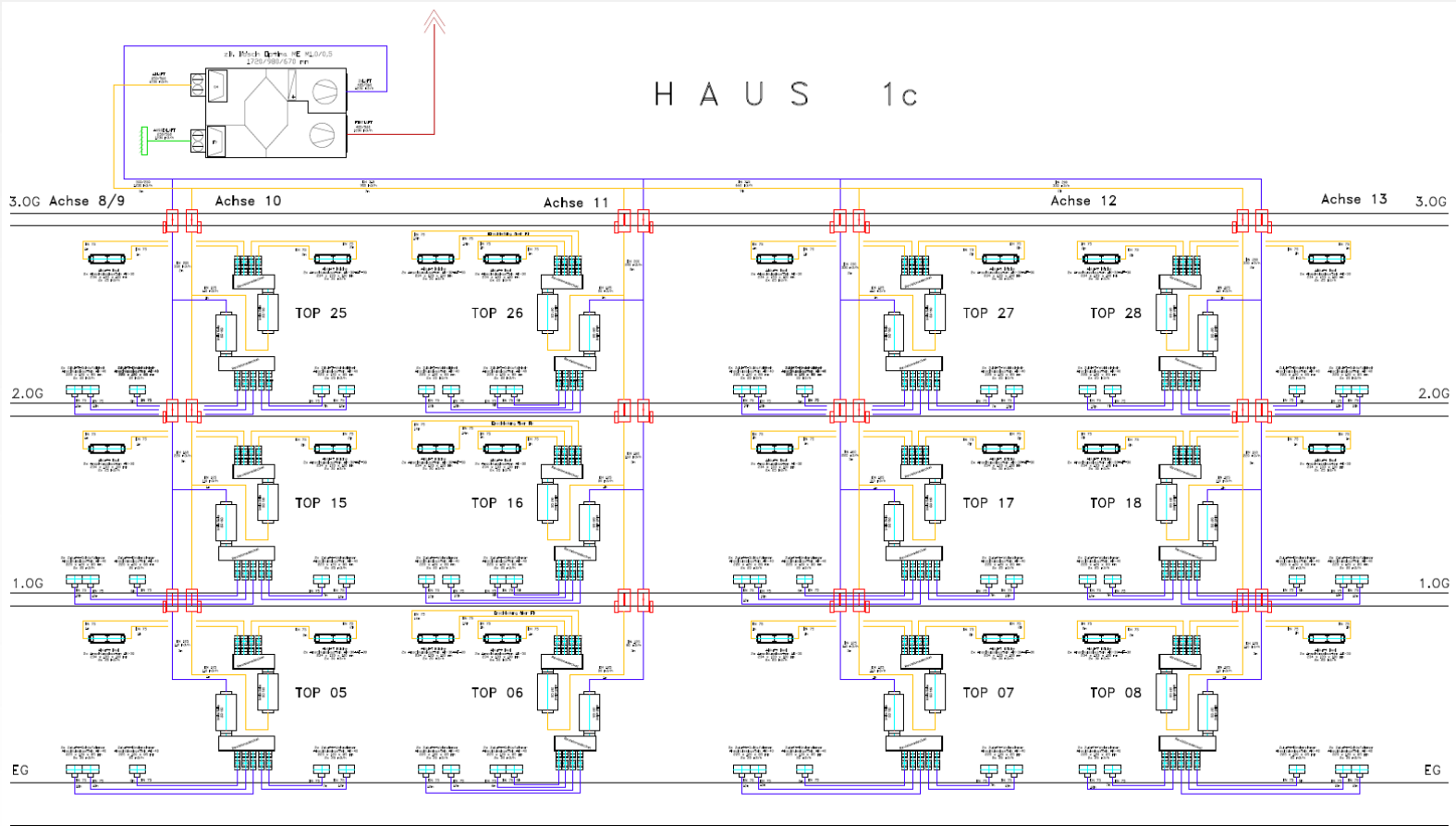

Hefel Lauterach

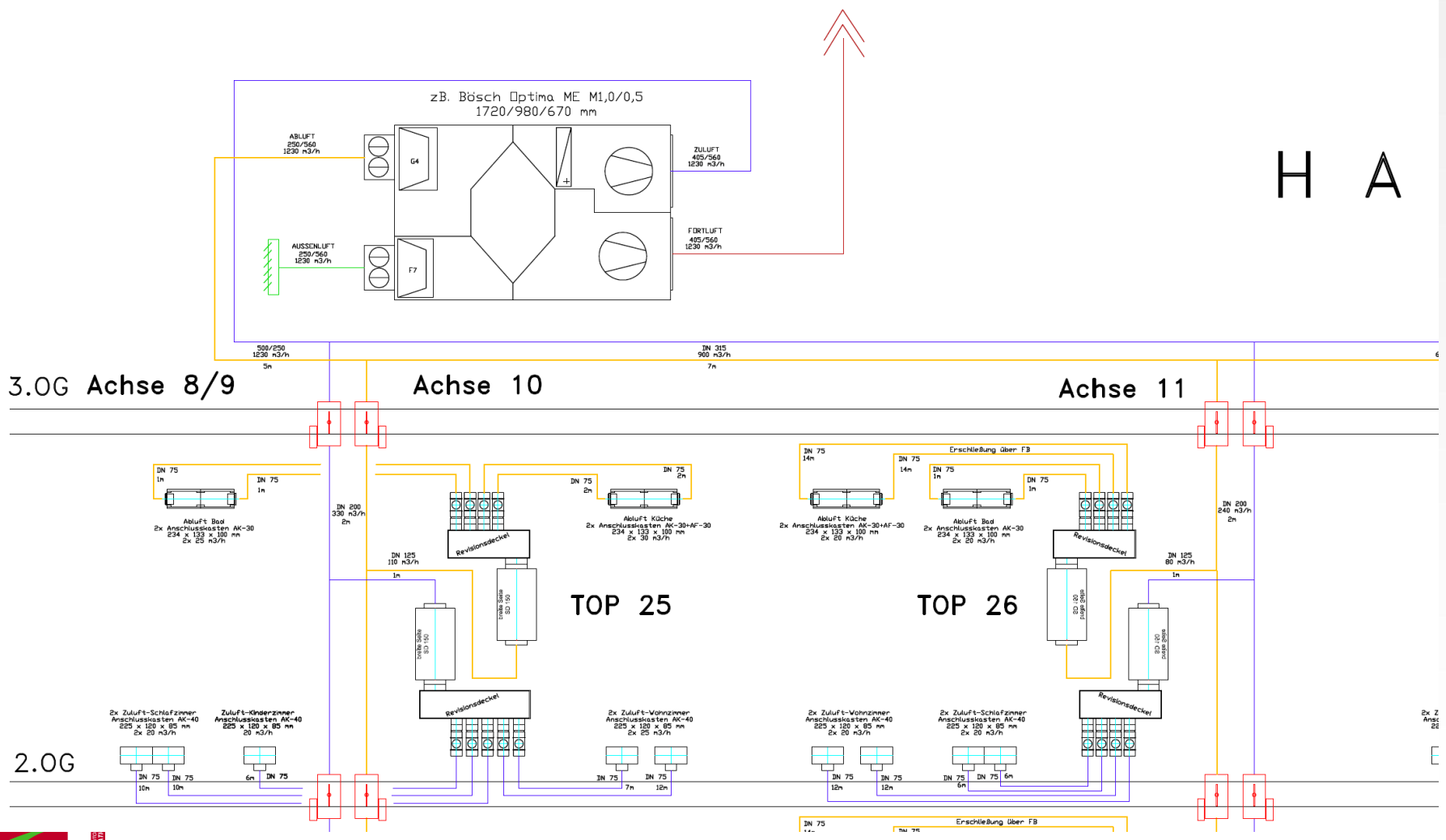

H A

Hefel Lauterach



Hefel Lauterach

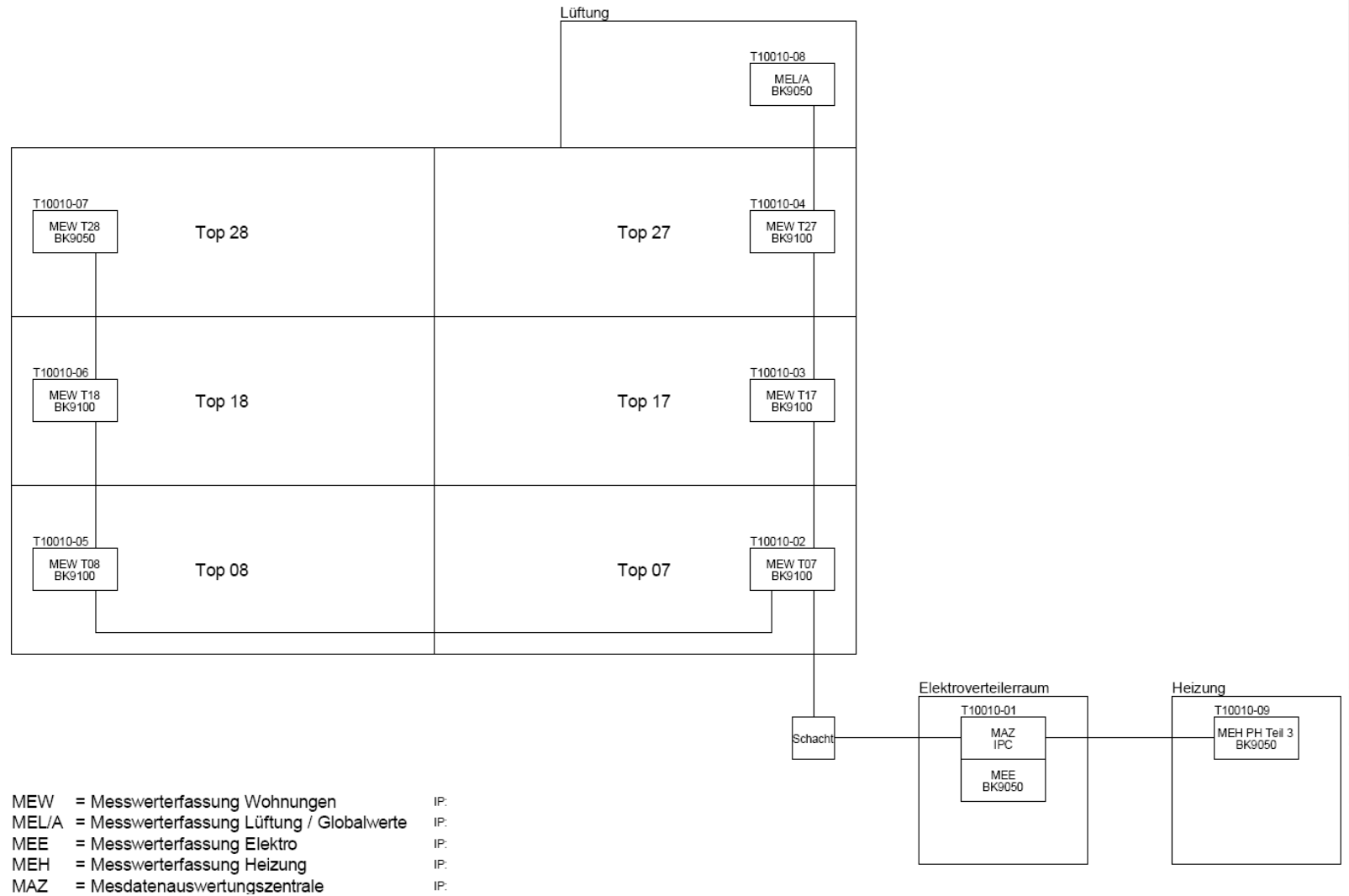

MEW = Messwerterfassung Wohnungen
 MEL/A = Messwerterfassung Lüftung / Globalwerte
 MEE = Messwerterfassung Elektro
 MEH = Messwerterfassung Heizung
 MAZ = Mesdatenauswertungszentrale

IP:
 IP:
 IP:
 IP:
 IP:

Hefel Lauterach



Lüftungsgerät

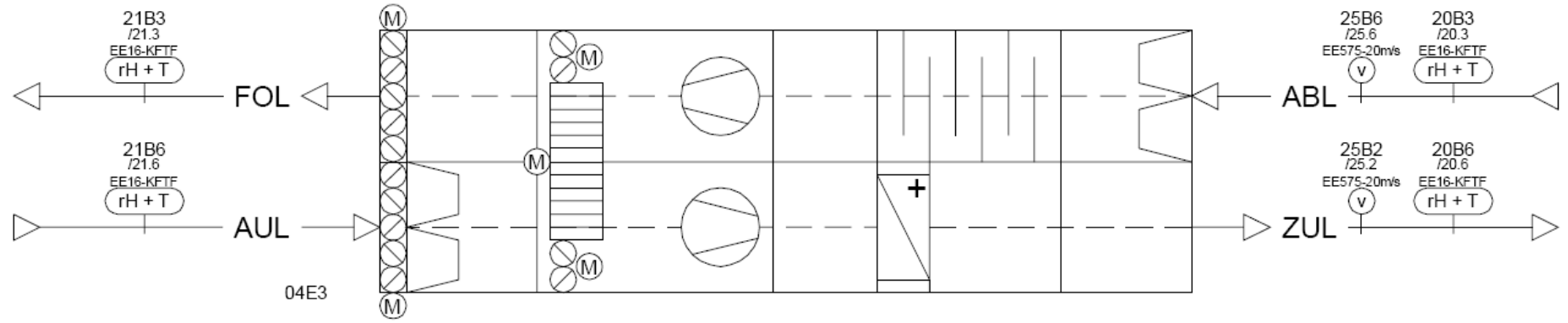

Hefel Lauterach

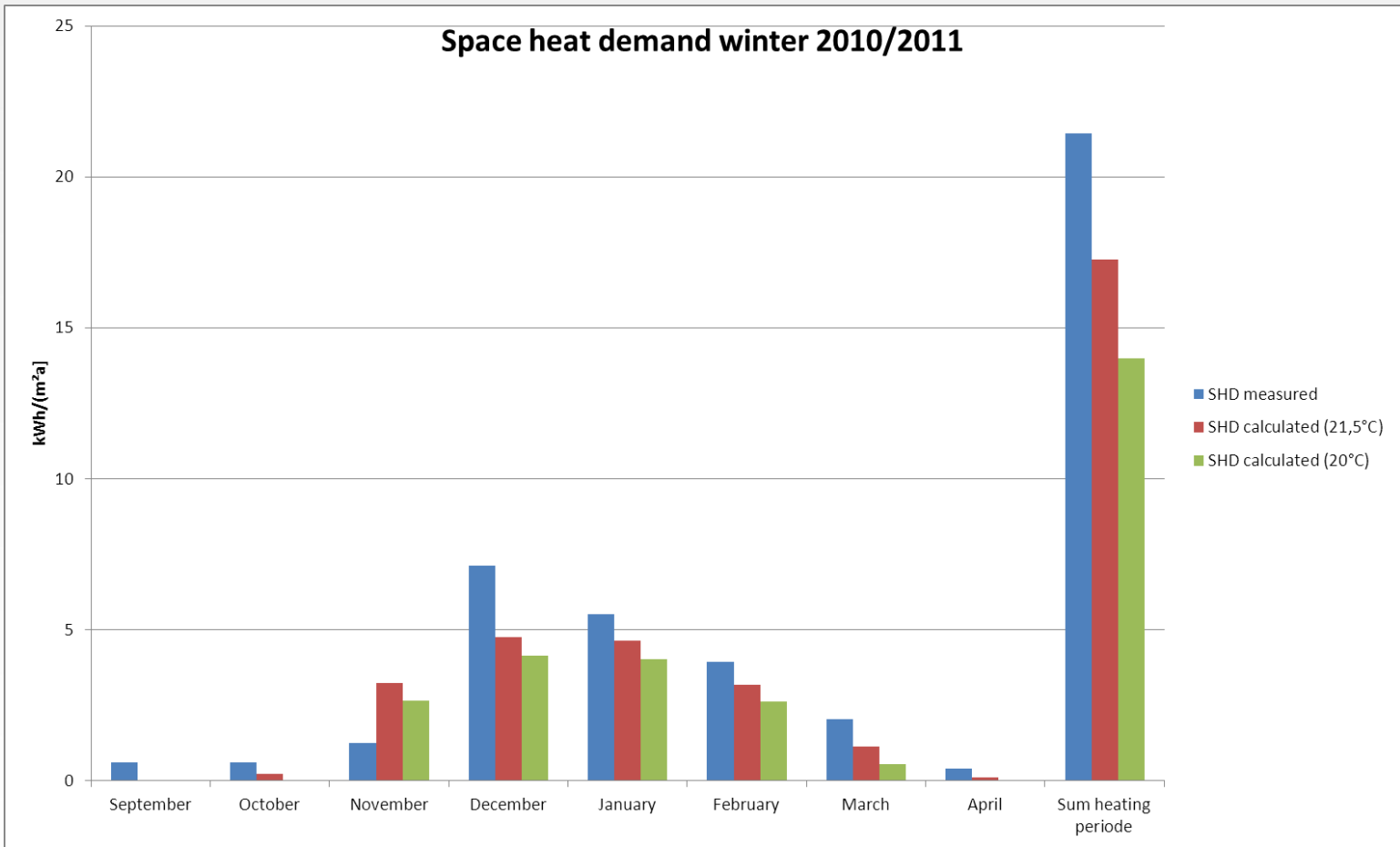

Hefel Lauterach

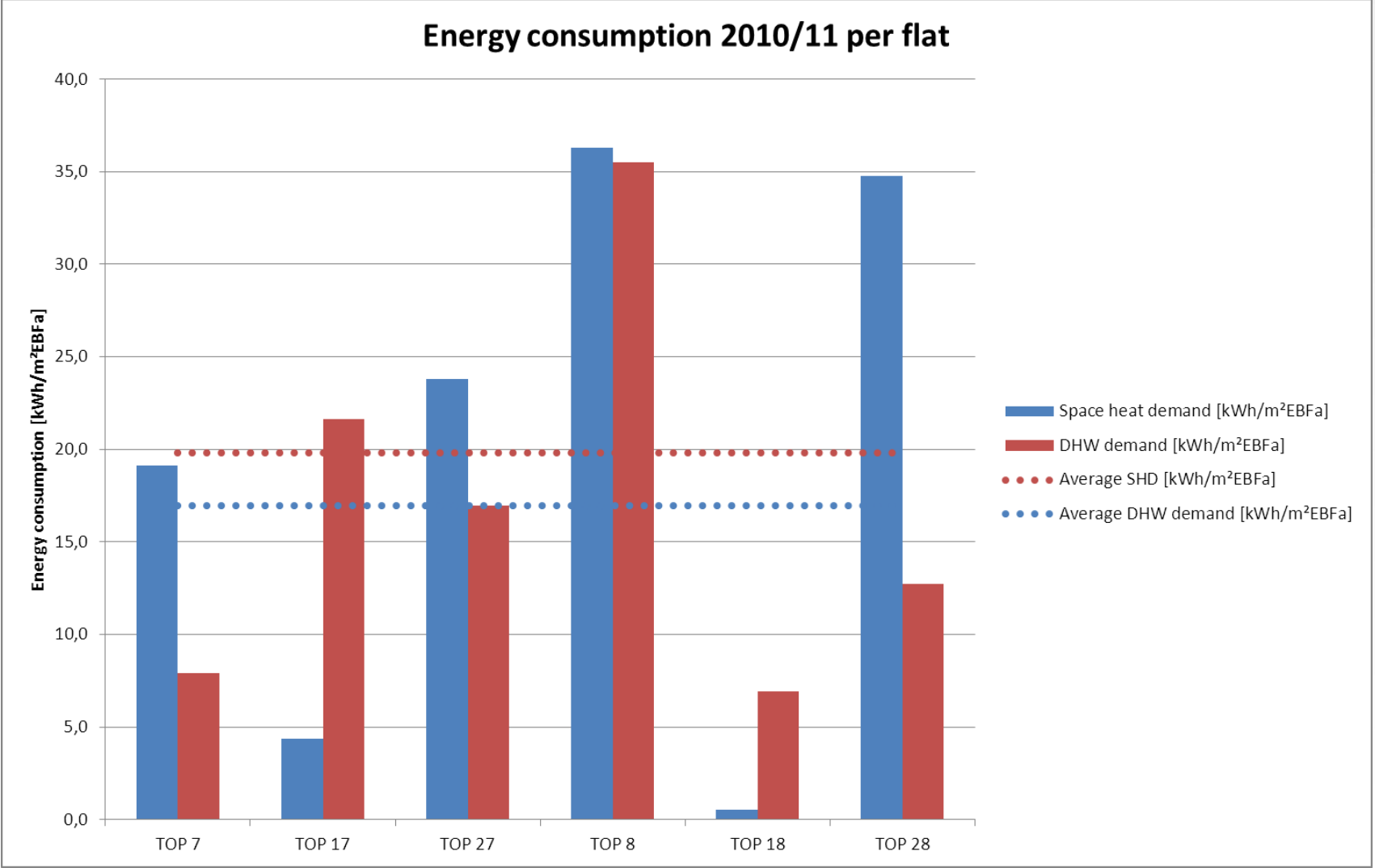

Hefel Lauterach

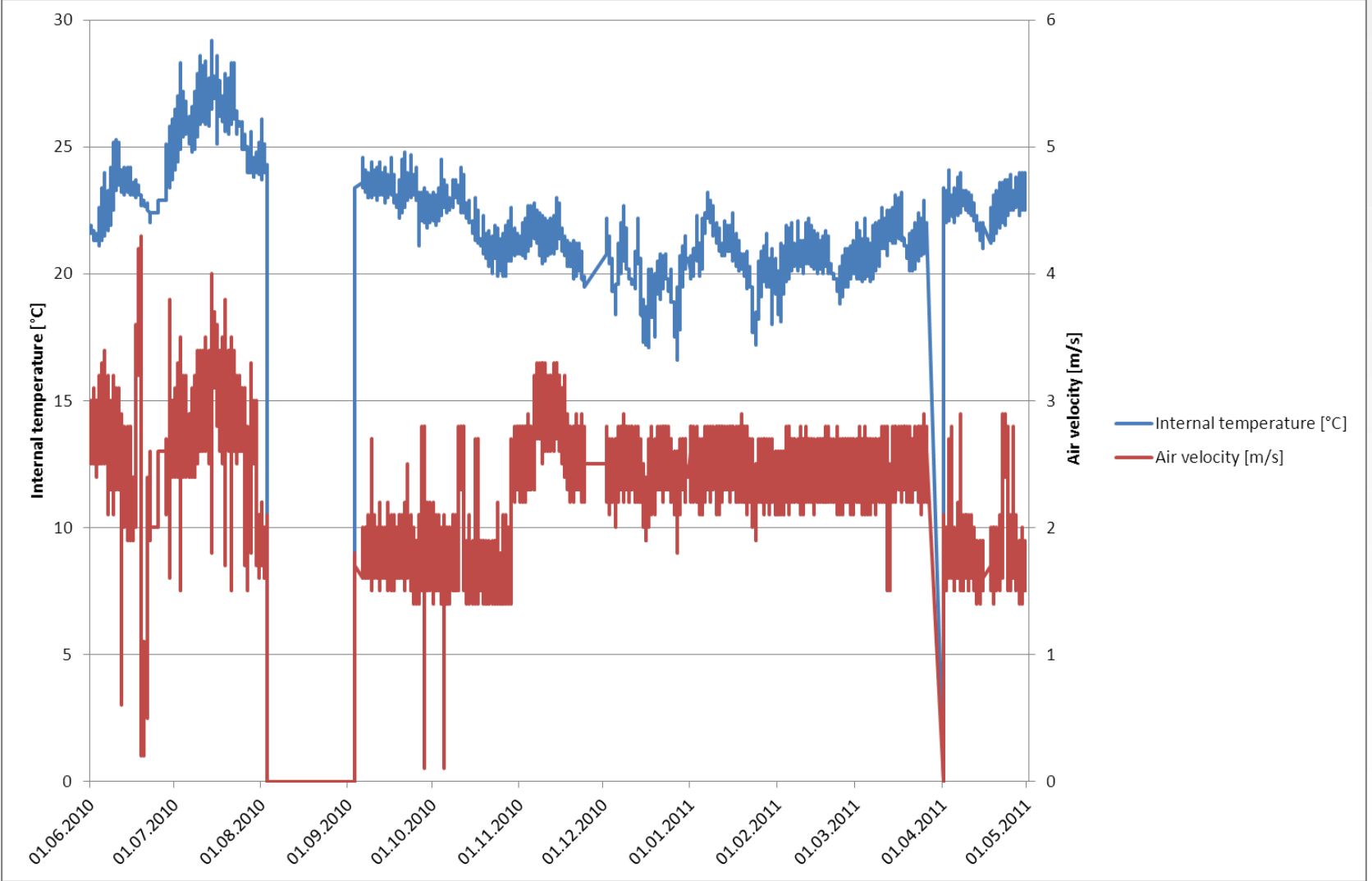

Hefel Lauterach

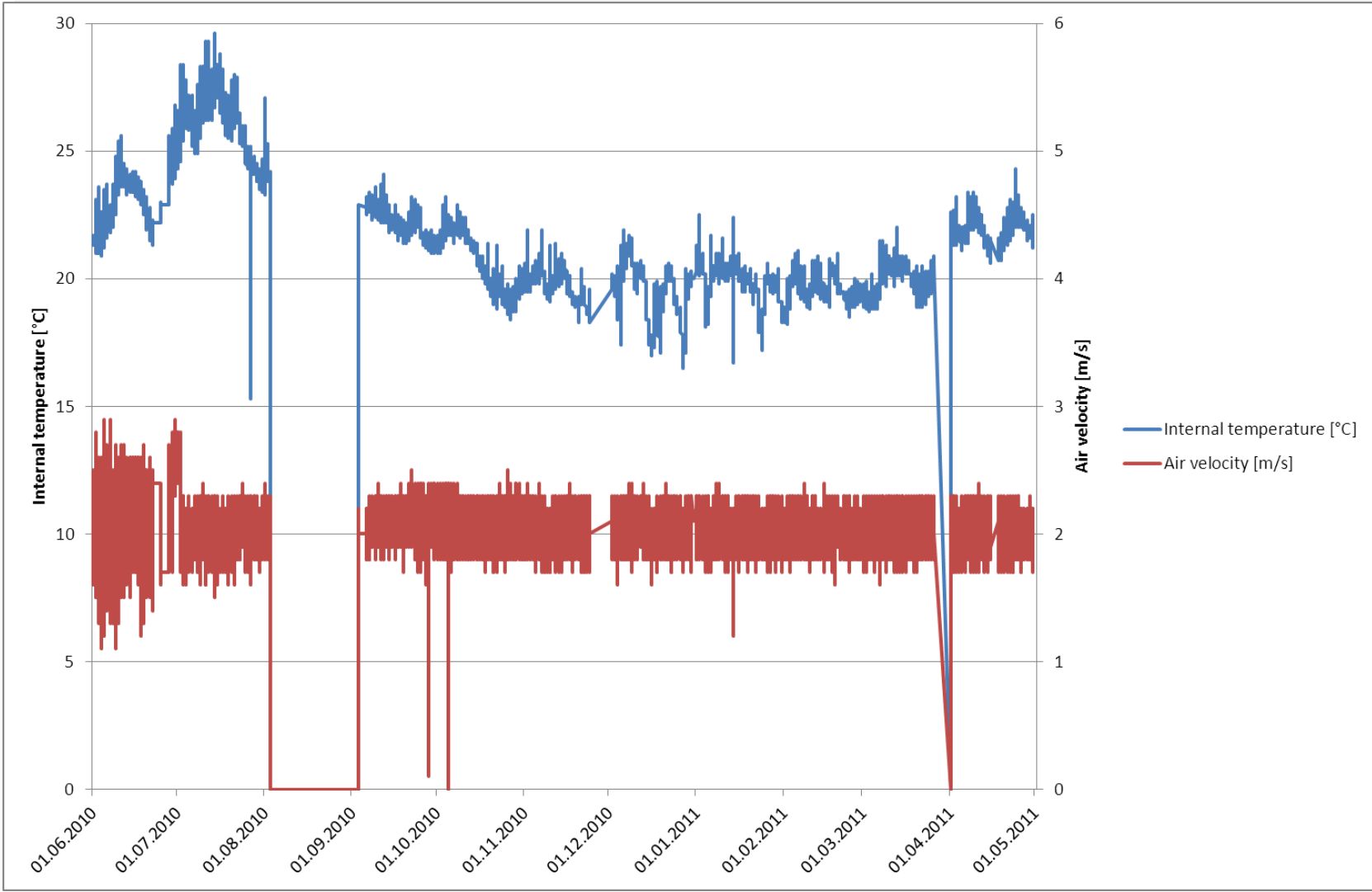

Hefel Lauterach

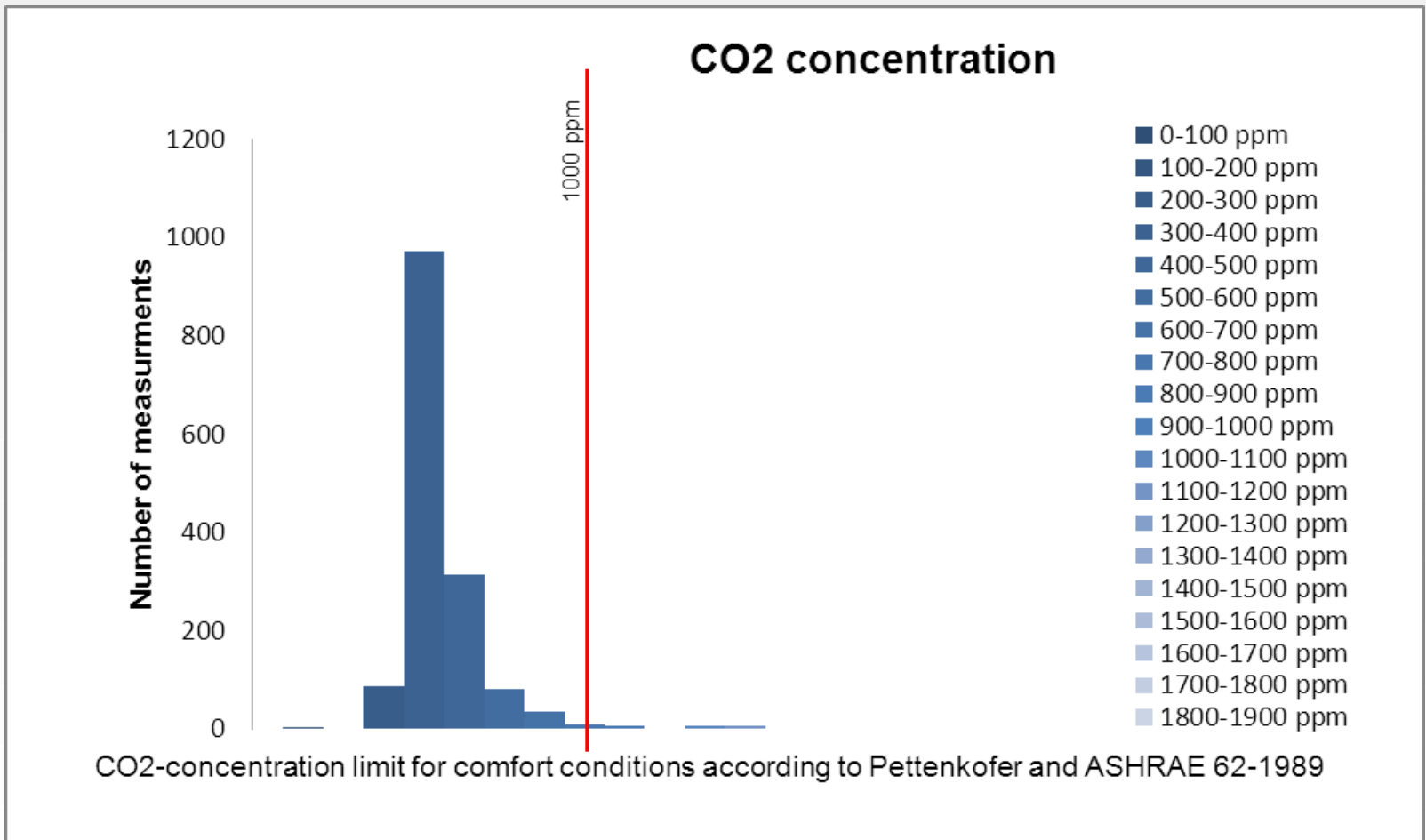

Hefel Lauterach

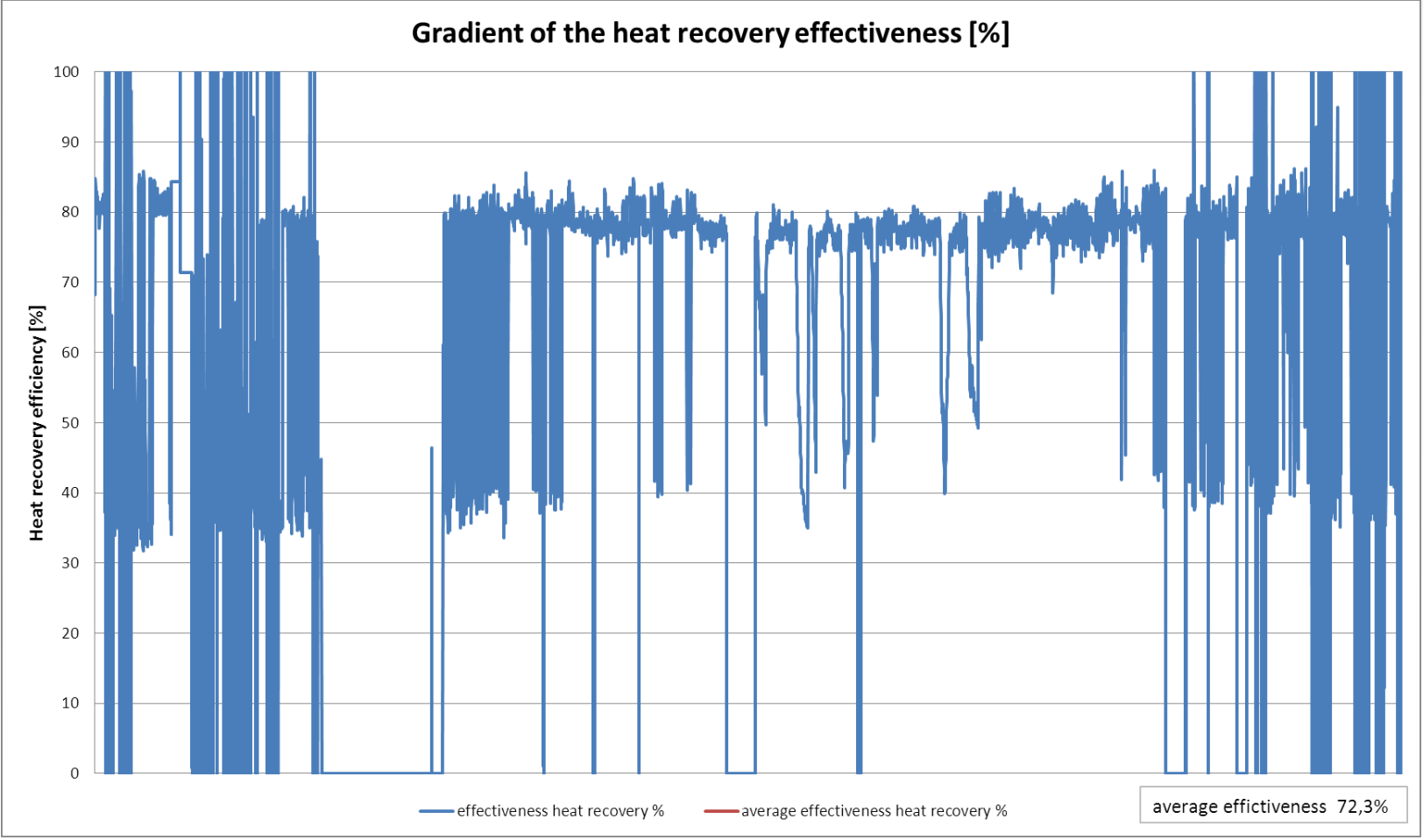

Hefel Lauterach

